

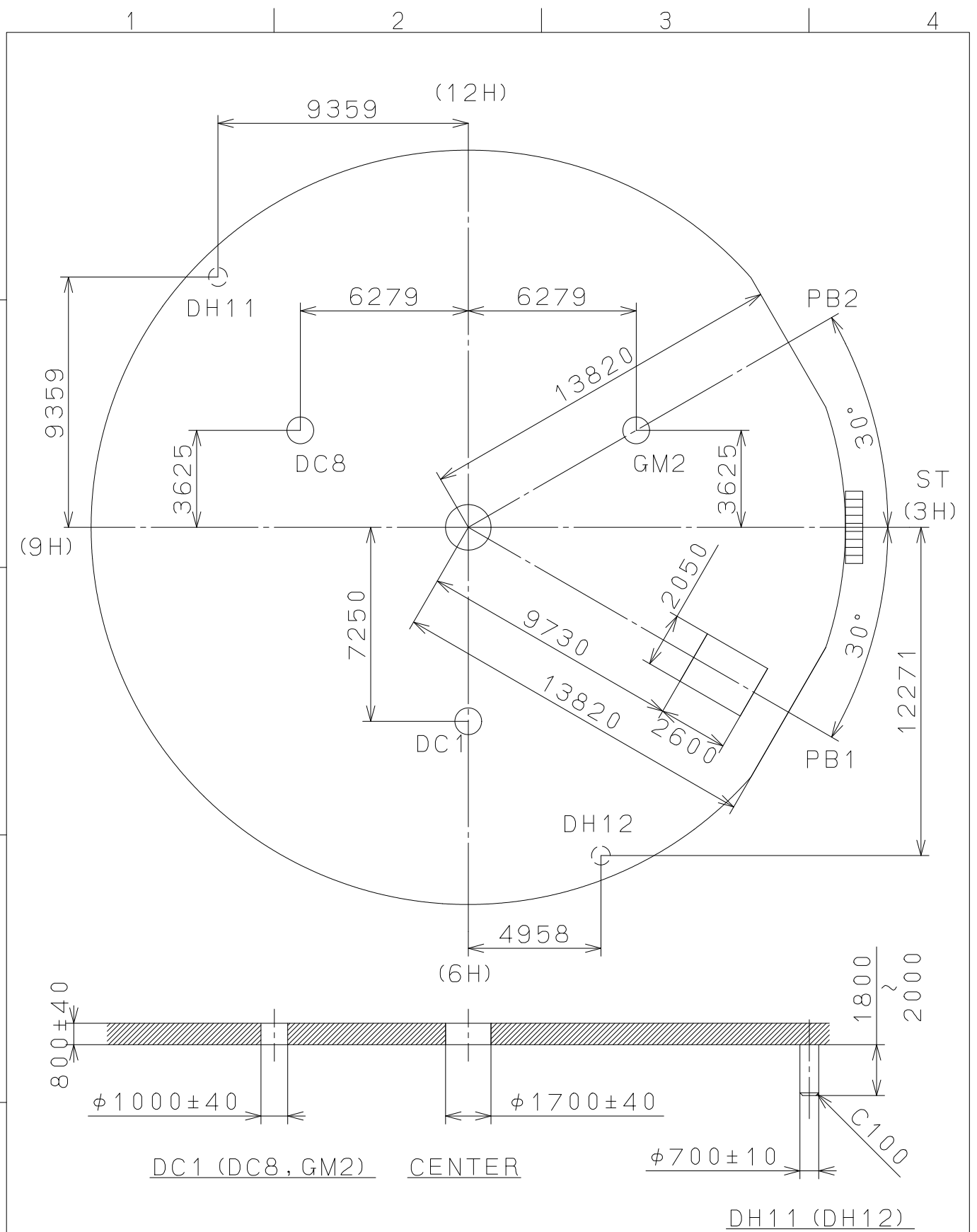

2010/02/01 (10:15:20)

This drawing is provisional and subject to our reconfirmation and/or revision without notice.



△			Quantity		Cal.NO.:
△			Unit	1/1000 <sub>mm</sub>	JS06-00C
△			Scale	5:1	Parts No.:
△			Date		
△			Drawn		
Mark	Date	Description	Appr.	Checked	Name:
		Alterations	Approved	N. Suzuki	Indications for Dial
Material					Drawing No.: JS06D000
Heat Treatment			General Tolerances		<b>MIYOTA</b>
Hardness			Dimensions		
Plating			Angles		
					CITIZEN WATCH CO., LTD. TOKYO, JAPAN

2006/12/25 (07:50:10)

This drawing is provisional and subject to our reconfirmation and/or revision without notice.

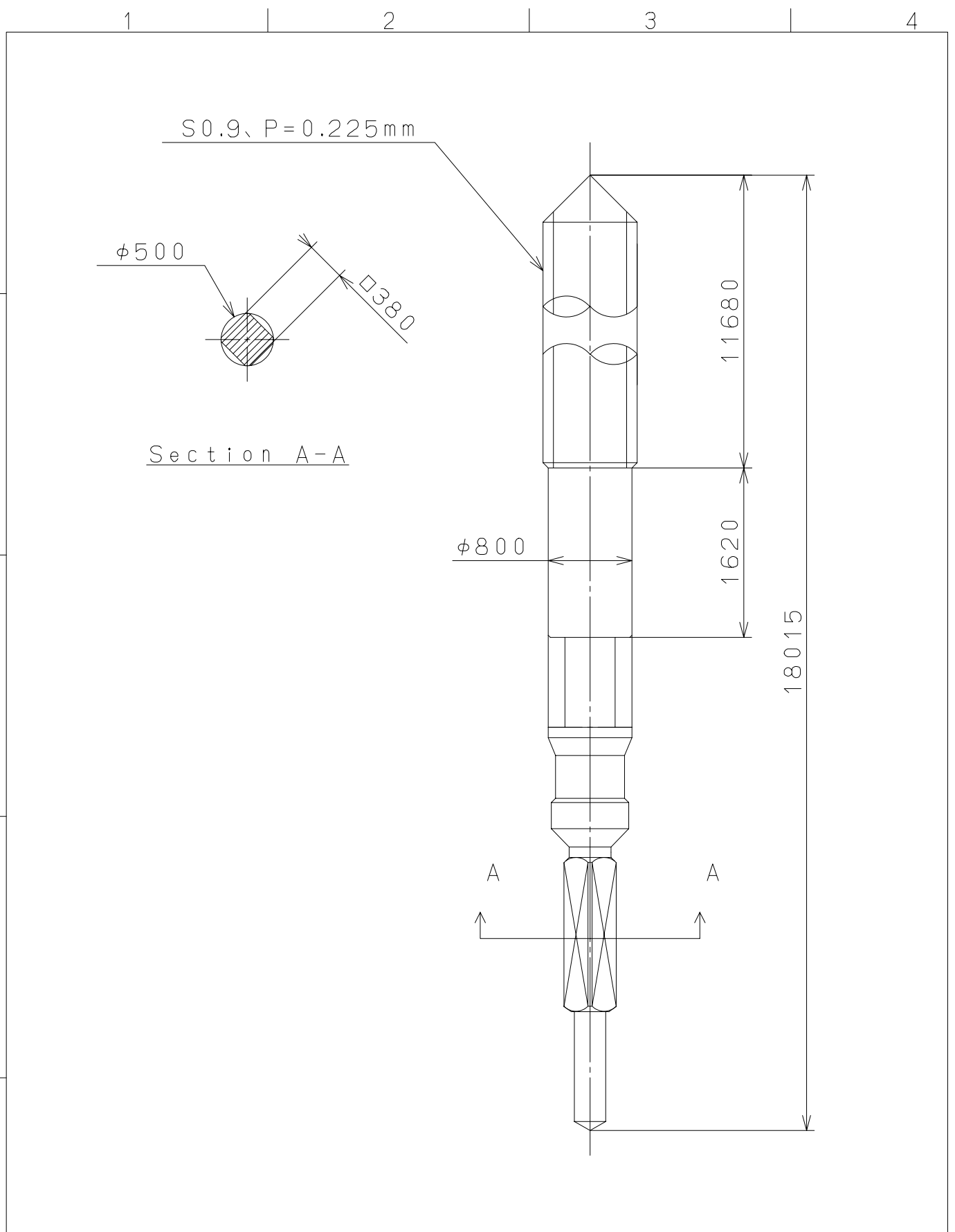

⑤			Quantity		Cal.NO.:
④			Unit	1 / 1000 mm	
③			Scale	20 / 1	Parts No.:
②			Date		065-505
①			Drawn		
Mark	Date	Description	Appr.	Checked	Name:
		Alterations		Approved	SETTING STEM
Material					Drawing No.: 5050S000
Heat Treatment				General Tolerances	<b>MIYOTA</b>
Hardness				Dimensions	
Plating				Angles	
					CITIZEN WATCH CO., LTD. TOKYO, JAPAN